

Varenummer: 2301077911  
 Beskrivelse: E+G Håndhjul  
 VR.375 FP+I

## Mål

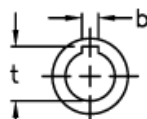
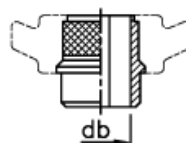
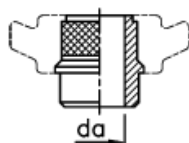
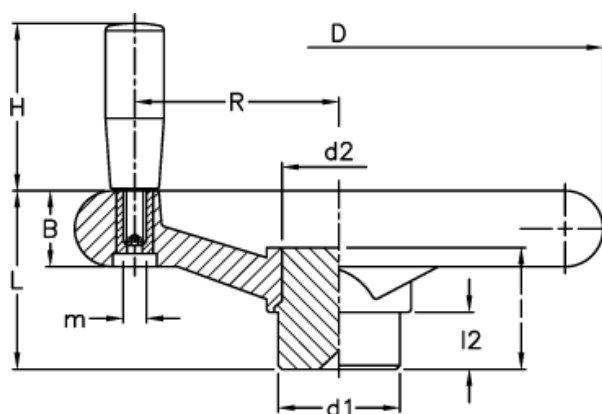

da max tilladelig  
boring uden not

db max tilladelig  
boring med not

b	= 12	H	= 100
B	= 40	l	= 77
C (N*m)	= 1450	L	= 108
D	= 375	L (J)	= 70
d1	= 58	l2	= 26
d2	= 58	m	= M12
da	= 45	R	= 160
db	= 40	t	= 43.3